



Philips
Professional TV

43" B-Line
powered by Android™



43BFL2214

Professional productivity

with Chromecast built-in and HDMI hotplug

Boost productivity. Philips B-Line seamlessly integrates into corporate systems for efficient control. Chromecast built-in ensures presentations run smoothly with instant wireless media sharing from Windows, Apple and Android™ devices.

Vibrant and efficient

- UHD resolution for attention grabbing content
- Chromecast built-in for wireless content sharing
- HDMI hotplug detection with auto on/off function
- Superb audio quality without external speakers
- Android updates provide the latest functionality
- Google Play Store access for apps and media

Smart control features

- Crestron Connected certified system integration
- Compatible with Extron and Neets systems
- Scheduler for content playback at selected times
- SmartInfo for custom content even when offline
- Operate, monitor and maintain via CMND & Control
- Install and manage apps remotely with AppControl

PHILIPS

Highlights

Chromecast built-in

Make meetings run smoother and faster with seamless wireless connectivity to the big screen from any Apple, Windows or Android™ device. Chromecast built-in enables instant casting of presentations and media from mobiles, laptops, and tablets in up to 4K resolution. It's cost-effective, requires no extra hardware, and is secure for corporate use.

HDMI hotplug detection

When wireless connectivity is not an option, HDMI hotplug detection recognises direct cabled connections from presentation sources and automatically handles source changes and on/off functioning.

Powered by Android

Android-powered Philips Professional TVs are fast, versatile and easy to navigate. The TVs are optimised for native Android apps and you can install web apps directly to the display too.

Automatic updates ensure apps stay up to date.

Google Play Store access

Full access to the entire Google Play Store makes it easy to add apps, games, music, movies, and more to your Philips Professional Display. New business tools and extra entertainment options are added to the catalogue daily, ensuring that you always have access to the latest global trends.

Crestron Connected certified

Connect this Philips Professional Display to your Crestron network for full remote control via your laptop, desktop or mobile device. Switch the display on and off, schedule content, manage settings, and easily connect external devices. Crestron Connected® provides a fast, reliable and secure enterprise level solution for wireless and wired content sharing from Apple, Windows, Android and Linux devices.

Scheduler for content playback

Built-in scheduler makes it easy to launch content and apps based on time of day for a more engaging environment with better results.

CMND & Control

Run your display network over a local (LAN or RF) connection. CMND & Control allows you to perform vital functions like updating software and settings, as well as monitoring display status. Whether you're in charge of one TV or more, CMND & Control makes managing your fleet easy.

AppControl

Take full, centralised control of the apps installed on your Philips Professional TVs. AppControl lets you install, delete, and manage apps on selected TVs or your entire network so that you can offer personalized experiences to your guests and customers-no matter how many TVs you are managing.

Specifications

Picture/Display

- Display: 4K Ultra HD LED
- Diagonal screen size: 43 inch / 108 cm
- Panel resolution: 3840x2160p
- Brightness: 350 cd/m²
- Contrast ratio (typical): 1200:1
- Operation Mode: Landscape, 16/7

Audio

- Sound output Power: 20 (2x10) W
- Speakers: 2.0, Down Firing
- Sound Features: DTS-HD, Dolby Atmos Compatible, Dolby MS12D, AC-4, DTS Studio Sound
- External speaker out: 1.5W Mono 8 Ohm

Design

- Colour: Black

Android TV

- Memory size(Flash): 16GB*
- OS: Android TV™ 9 (Pie)
- Pre-installed apps: YouTube, Google Play Store*, Google Play Movies, Google Play Games, YouTube Music

Tuner/Reception/Transmission

- Digital TV: DVB-T/T2/C, HEVC UHD (up to 2160p60)
- Analog TV: PAL
- IP Playback: Multicast, Unicast, HLS, OTT App Channels

Wireless Connectivity

- Wireless LAN: 802.11 ac, Wifi-Direct

Connectivity Side

- Common Interface Slot: CI+ 1.3.2
- USB1: USB 3.0
- Headphone out: Mini-Jack
- HDMI1: HDMI 2.0 with HDCP 2.2

Connectivity Bottom

- External power: 12V, max 1.5A
- Ethernet (LAN): RJ-45
- Antenna: IEC-75
- External speaker out: Mini-Jack
- External Control: RJ-48
- USB2: USB 2.0

- HDMI2: HDMI 2.0 with HDCP 2.2
- HDMI3: HDMI 2.0 with HDCP 2.2

Connectivity Enhancements

- HDMI: ARC (all ports), Auto Input Selection
- EasyLink (HDMI CEC): One touch play, System Standby, RC pass through, system audio control
- RJ48: IR-In/Out, Serial Xpress interface

Corporate Features

- Wired Presentations: Auto Input Selection, Auto Power ON, Auto Power OFF
- Wireless Presentations: Chromecast built-in, Secure Sharing, Network-managed Sharing
- Signage Functions: CMND&Create, Scheduler, Banners
- Control: Crestron Connected (v2), Extron, Neets, SICP over IP
- Customizable: Home Screen, Location Name, Device Name

Professional TV Features

- Professional Mode: Switch-ON Settings Control, Installation Menu Lock, Menu Lock, Volume Limitation
- Control: CMND IP Remote Management, JEDI Android API Control, JAPIT HTML5 Control, AppControl
- Convenience: Google Assistant*, Google Account Login, >40 Supported Menu Languages, Weather Forecast
- Safety: Double Isolation Class II, Flame Retardant

Multimedia

- Video playback supported: Formats: H.264/MPEG4 AVC, MPEG1, MPEG2, MPEG4, WMV9/VC1, HEVC, Containers: AVI, MKV, VP9
- Subtitle formats supported: SRT, SMI, TXT
- Music formats supported: MP3, AAC, WAV, WMA (v2 up to v9.2), WMA-PRO (v9 and v10)
- Picture formats supported: JPG, PNG, BMP, GIF

Supported Display Resolution

- Tuner: T2 HEVC: up to 3840x2160@60Hz, Others: up to 1920x1080p@60Hz
- HDMI: Up to 3840x2160p@60Hz
- USB, LAN: HEVC: up to 3840x2160@60Hz, Others: up to 1920x1080p@60Hz

Accessories

- Included: Remote Control 22AV1905A/12, 2x AAA batteries, Power Cord, RJ48 to DB9 adapter
- Optional: Setup RC 22AV9574A/12

Power

- Mains power: AC 220-240V; 50-60Hz
- EPREL registration number: 956378
- Energy Label Class: F
- Eu Energy Label power: 51 W
- Standby power consumption: <0.3W
- Power Saving Features: Eco mode, Auto switch-off timer, Light sensor
- Ambient temperature: 0 °C to 40 °C

Dimensions

- Set dimensions (W x H x D): 958 x 560 x 77/80 mm
- Product weight: 7.6 kg
- VESA wall mount compatible: M6, 100 x 200 mm

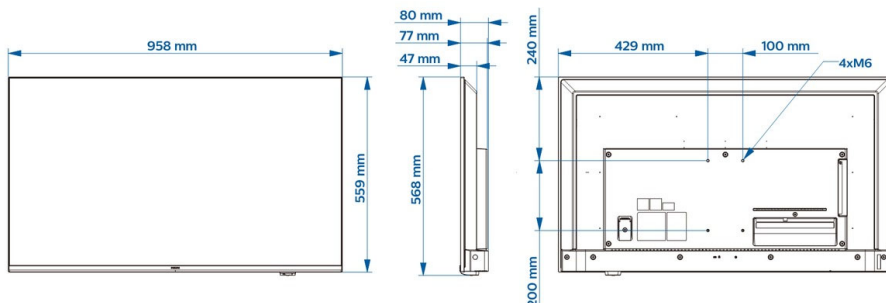

Issue date 2021-12-13

Version: 1.0.1

12 NC: 8670 001 80675
EAN: 87 18863 03258 9

© 2021 Koninklijke Philips N.V.
All Rights reserved.

Specifications are subject to change without notice.
Trademarks are the property of Koninklijke Philips N.V.
or their respective owners.

www.philips.com

* Availability of features will depend on implementation chosen by integrator.
* Philips does not guarantee the availability or continuity of correct functioning of apps.
* Actual free memory may be less due to device pre-configuration
* Typical on-mode power consumption measured according to IEC62087 Ed 2. The actual energy consumption will depend on how the television is used.
* This television contains lead only in certain parts or components where no technology alternatives exist in accordance with existing exemption clauses under the RoHS Directive.
* Google Cast requires access to Google servers.
* Availability of Google Assistant is depending on Country and Language settings. To use Google Assistant, an optional remote control with voice function must be used.
* Android, Google Play and Chromecast are trademarks of Google LLC